

MB-20

Machine-room above electrical gearless solutions

High efficiency for buildings with low traffic.
Optimum use of space and latest direct drive (Gearless) technology.
The standard solution.
Latest technology, affordable and functional.



GENERAL SPECIFICATIONS



Load	320 - 450 - 630 kg
Capacity	4 - 6 - 8 persons
Speed	1 m/s
Maximum travel	45 m
Maximum floors served	16 floors
Entrances	1 front - 2 open through - 2 front & side
Drive system	Direct gearless
Controller	ARCA II controller, low energy microprocessor
Door types	Automatic side-opening - Automatic central-opening
Clear door opening	700 - 800 - 900 mm
Door height	2,000 - 2,100 mm
Car dimensions	Standard car dimensions
Internal car height	2,100 - 2,200 mm
Aesthetic solutions	MBR1 - MBR2 - MBR3 - MBR4 - MBS1 - MBS2 - MBS3 - MB Plus



Standard **Optional**



- 1 Machine room** 
A traditional solution simplifying lift maintenance.



- 2 Optimised passenger unit**   
Saves space, reduces weight, improves safety, and improves the installation process.

- 3 Accessible space bellow the pit**  
Adapts the lift to suit buildings which have an accessible space below the pit (optional).

- 4 Traction ropes**  
Orona small diameter ropes replace traditional steel ropes. As a result of their lighter weight, longer lifespan and greater flexibility, it is possible to use a more compact, efficient and eco-friendly gearless machine.

- 5 Drive**   
Compact, quiet, gearless, energy efficient, speed regulated (VVVF) permanent magnet electric motor.

- 6 Doors**   
Compact permanent magnet motor for quick, accurate and quiet door operation giving the most advanced performance. Advanced door opening and full height infra red door protection edges. Optional Solid Door for high flow situations.

- 7 Automatic rescue system**  
With floor level indication to ensure fast, efficient and safe evacuation of passengers in the event of an emergency. As an option, the system can incorporate a fully-automatic rescue device to evacuate passengers in the event of a power failure.

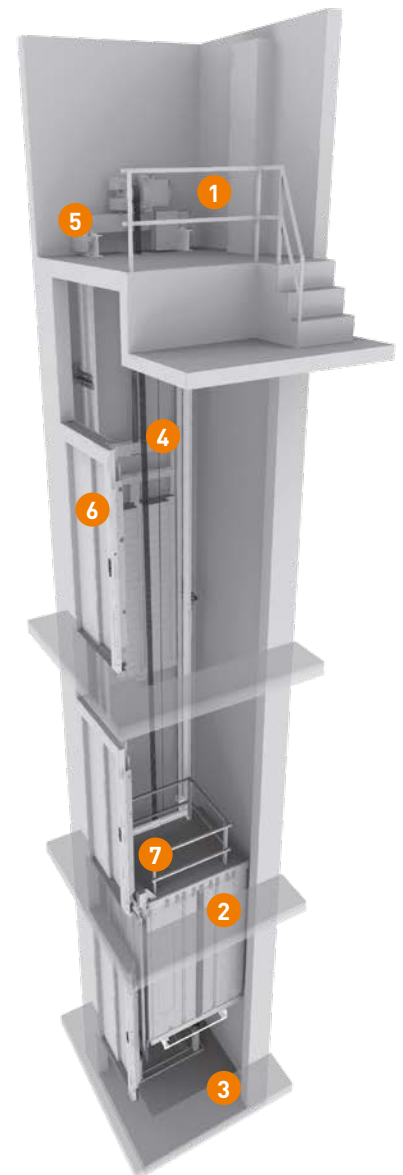

STANDARD DIMENSIONS

Load / Capacity		Car			Lift shaft *							
Persons	Q Load	AC Width	FC Depth	PL Clear opening	Entrances		Side-opening doors		Central-opening doors		HF Pit	HUP Last Floor
					Accessibility	No. of entrances	AH ¹ Width	FH ² Depth	AH Width	FH ³ Depth		
4	320 kg	825	1,100	700		1	1,325	1,350	1,600	1,300	1,000 (850) ⁴	3,400
						2 x 180°		1,500		1,400		
						2 x 90°	1,450	1,350				
6	450 kg	1,000	1,250	800	♿	1	1,500	1,500	1,800	1,450	1,000 (850) ⁴	3,400 (3,000) ⁵
						2 x 180°		1,650		1,550		
						2 x 90°	1,625	1,500				
8	630 kg	1,100	1,400	900	♿	1	1,600	1,650	2,000	1,600	1,000 (850) ⁴	3,400 (3,000) ⁵
						2 x 180°		1,800		1,700		
						2 x 90°	1,725	1,650				
		1,200	1,250	900	♿	1	1,700	1,500	2,000	1,450		3,400
						2 x 180°		1,650		1,550		
						2 x 90°	1,825	1,575				

1. Accessible space below the pit (counterweight with safety gear) add 50 mm to AH.
2. Shaft depth with door tracks projecting 60 mm on the landing.
3. Shaft depth with door tracks projecting 40 mm on the landing.

4. HF reduced pit optional 850 mm.
 5. HUP minimum for internal car height (HC) 2,100 mm (HUP = HC + 1,300).
HUP reduced headroom optional only for 6 and 8 persons (HUP = HC + 900).
- * Minimum plumb measurements.

LAYOUT

1 Entrance

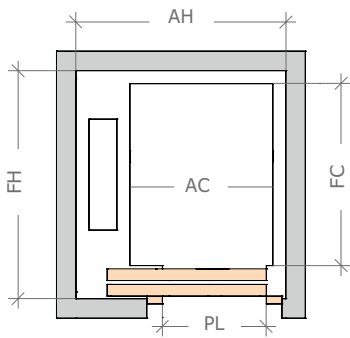

Wide-framed door detail

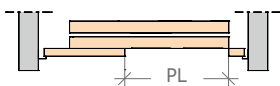

2 Entrances (open through)

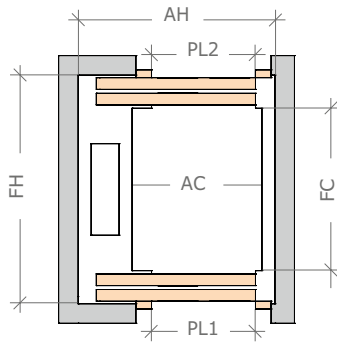

2 Entrances (front & side)

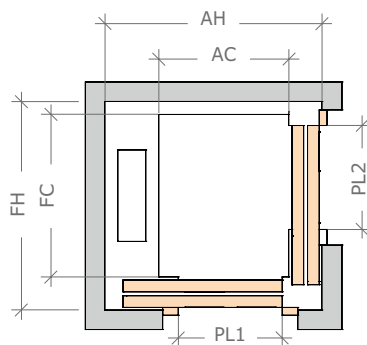

Vertical section

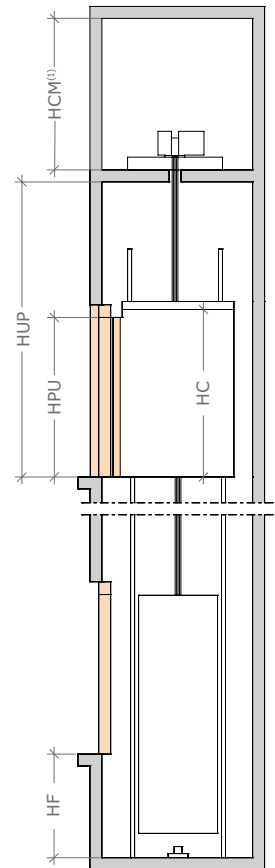

(1) HCM - minimum 2,000 mm